

CAMERA & ILLUMINATOR MOUNTING SOLUTIONS

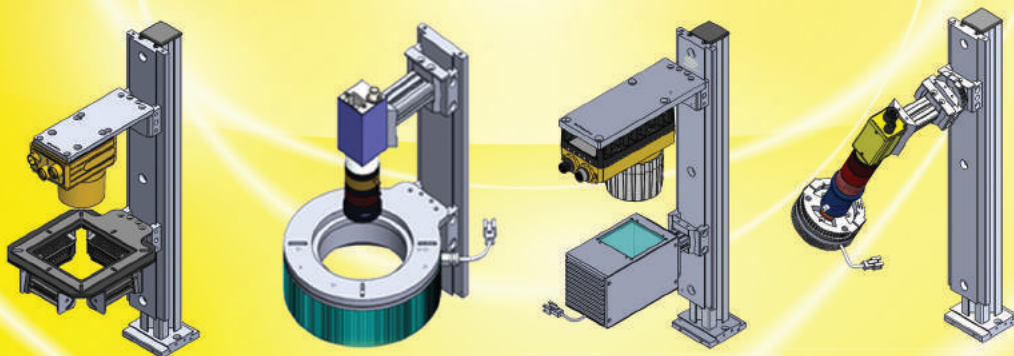

Camera Compatibility Identifier

The camera's illustrated below are compatible with the modules

ALLIED VISION

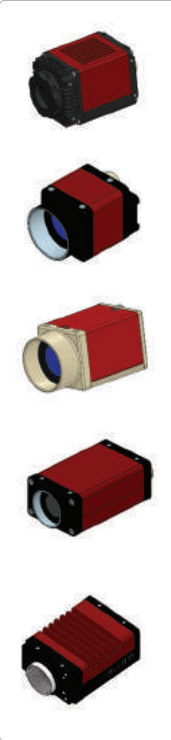

COGNEX

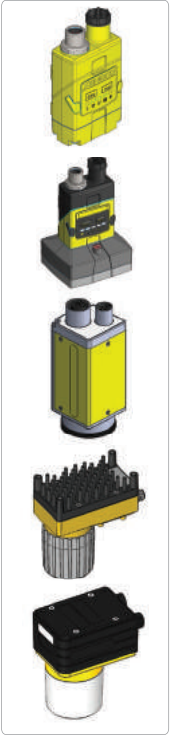

HIK-VISION

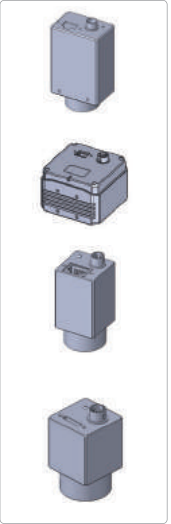

FLIR

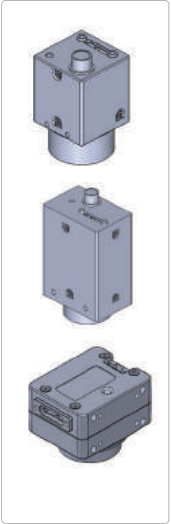

NATIONAL INSTRUMENTS

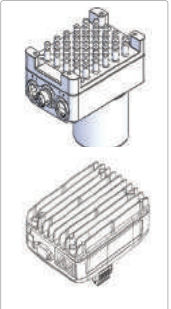

MATRIX VISION

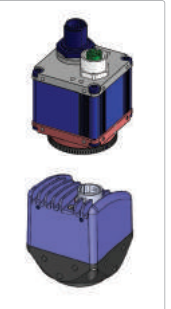

DATALOGIC

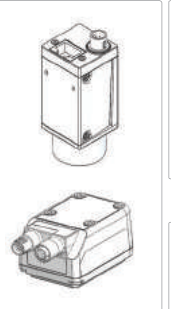

TELEDYNE

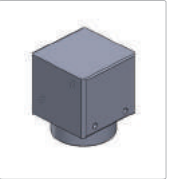

SENSOPART



TELE-TOSHIBA

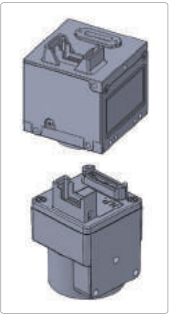

OMRON

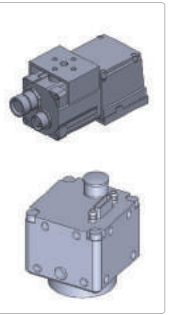

BASLER

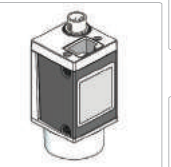

KEYENCE

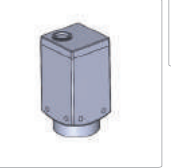

WENGLOR



Camera and Illuminator Module Sets











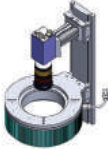















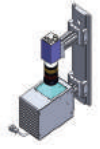











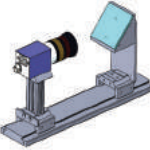

- Quickly and easy mounted onto machine & system
- Suitable for small production, laboratories and demonstrations

FULL ASSEMBLY

CAMERA/LIGHTING
ASSEMBLY

MODULE ASSEMBLY

MODULE

			 <p>Vertical Track VT-195 VT-245 VT-328</p>	 <p>Camera Plate Rotation Module CMV-BAS-50.5-ACE</p>		 <p>LPR-019-024045-01 LPR-036-045070-01 LPR-057-065092-01 LPR-084-095120-01</p> <p>Lighting Plate Round</p>	 <p>LP-IDSA-050 LP-IDSA-070 LP-IDSA-100</p> <p>Lighting Plate Dome</p>	 <p>LPS-010-015035-01 LPS-026-03506-401 LPS-055-062099-01 LPS-080-088136-01</p> <p>Lighting Plate Square</p>
			 <p>Vertical Track VT-195 VT-245 VT-328</p>	 <p>Extrusion bar & Camera Module CMV-BAS-50.5-ACE</p>				
			 <p>Lighting Module CC-LS-01</p>	 <p>Lighting Plate Round</p>				
			 <p>Lighting Plate Coaxial 25 CS-CAS25-01</p>	 <p>Lighting Plate Coaxial 40 CS-CAS40-01</p>		 <p>Lighting Plate Coaxial 40 CS-CAS40-01</p>	 <p>Lighting Plate Coaxial 40 CS-CAS40-01</p>	 <p>Lighting Plate Coaxial 40 CS-CAS40-01</p>
			 <p>Lighting Plate Coaxial 40 CS-CAS40-01</p>					
			 <p>Lighting Module CC-LS-01</p>	 <p>Prism Module 35 CC-PM35X50-01</p>		 <p>Lighting Module CC-LS-01</p>	 <p>Prism Module 53 CC-PM53X50-01</p>	 <p>Lighting Module CC-LS-01</p>
			 <p>Lighting Module CC-LS-01</p>	 <p>Prism Module 53 CC-PM53X50-01</p>				

Camera and Illuminator Module Sets











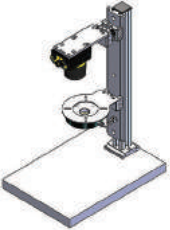





- Quickly and easily mounted onto machine & system
- Suitable for small production, laboratories and demonstrations

FULL ASSEMBLY

CAMERA/LIGHTING
ASSEMBLY

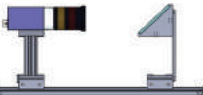
MODULE ASSEMBLY



MODULE

			 <p>Vertical Track VT-195 VT-245 VT-328</p>	 <p>Camera Plate Module CH-025</p>			
			 <p>Vertical Track VT-195 VT-245 VT-328</p>	 <p>Camera Plate Hotation Module</p>			
			 <p>Lighting Module CCLS-01</p>	 <p>Lighting Plate Round</p>	 <p>Lighting Plate Dome</p>	<p>LP-IDS4-050 LP-IDS4-070 LP-IDS4-100</p>	 <p>Lighting Plate Square</p> <p>LPS-010-015035-01 LPS-025-035064-01 LPS-055-062099-01 LPS-080-088136-01</p>
			 <p>Lighting Plate Coaxial 25 CS-CAS25-01</p>	 <p>Lighting Plate Coaxial 40 CS-CAS40-01</p>			
			 <p>Lighting Module CCLS-01</p>	 <p>Prism Module 35 CC-PM35X50-01</p>			
			 <p>CCLS-01</p>	 <p>Prism Module 53 CC-PM53X50-01</p>			

Camera and Illuminator Module Sets







- Space efficient
- Quick & easy mounting
- Cost efficient

FULL ASSEMBLY CAMERA/LIGHTING ASSEMBLY MODULE ASSEMBLY MODULE

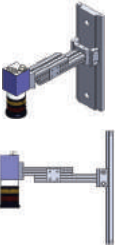
			 <p>Vertical Track VT-195 VT-245 VT-328</p>	 <p>Camera Plate Rotation Module CMV-BAS-50.5-ACE</p>	
	 		 <p>Small mounting plate module for lens M25.5 MK32-C2-M25.5-2807D-01</p>	 <p>Small mounting plate module for lens M30.5 MK32-C2-M30.5-2807D-01</p>	 <p>Large mounting plate module for lens M25.5 MK32-C2-M25.5-491D2-01</p>

EXTENSION BARS

- Adjustable to desired distance

			 <p>Extension Bar 80mm</p>	 <p>Extension Bar 100mm</p>	 <p>Extension Plate (2pcs)</p>
---	---	---	---	--	---

Camera and Illuminator Mounting Solution Kits

Guide to setup: <https://www.youtube.com/watch?v=BsATdrmfRC8>

VERTICAL MOUNT



LPR SERIES Lighting Series (DLR2,LSW,LLA,ICD)

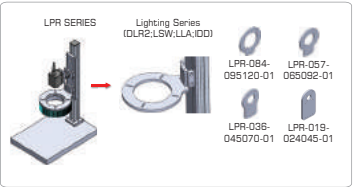

LP-IDS4 SERIES Lighting Series (IDS4)



ROTATION MOUNT

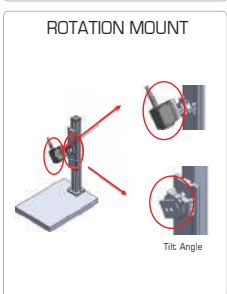

LPS SERIES Lighting Series (LSQ,LBRX,LBRQ,DLF2)

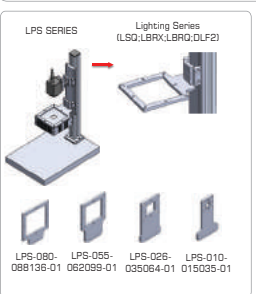

LP-CAS SERIES Lighting Series (CAS2,CAS2)

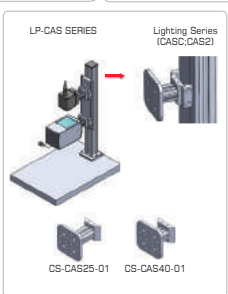

Additional Lighting Bracket

LPB SERIES Lighting Series (LBRX,MLB0)

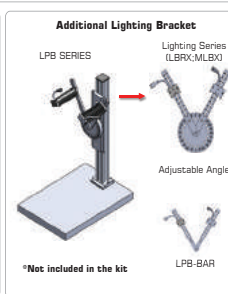

**Not included in the kit*

- 1) Applicable in laboratory, small production and demonstration
- 2) Module can mount directly to machine
- 3) Portable and convenient to carry
- 4) Easy to set up
- 5) Suitable mount for various camera module and illuminator
- 6) One stop solution for camera module and illuminator
- 7) *Applicable with illuminator advance demo kit v2. DK-AD-LINGTING-V2

OPTIONAL EXTRA

Adjustable XYZ Table (XYZ-100-080-050)

Provides Flexibility For Fine Tuning

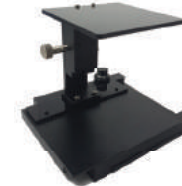

Flexible Arm (FA-120-060)

Provides additional flexibility in obtaining the required angle and may be utilised for both camera and lighting.



*Illuminator Advance Demo Kit - V2 (DK-AD-LINGTING-V2)

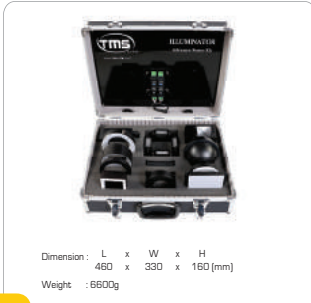

Dimension : L x W x H
460 x 330 x 160 (mm)

Weight : 6600g

S/N	Content	Description		
1	LBRX-00-080-3-R-24V	Rectangular Illumination	11	BHS4-00-090-X-R-24V Thin Backlight Illumination
2	LBRX-00-080-6-W-24V	Rectangular Illumination	12	IDS4-00-100-1-W-24V Indirect Illumination
3	LBRQ-00-040-3-W-24V	Multiple Rectangular Illumination	13	CAS2-00-040-X-W-24V Coaxial Illumination
4	LSW-15-090-4-W-24V	Direct Illumination	14	SD-2000-D1 Analogue Controller 2CH SD-1000-D1
5	LSW-30-090-4-W-24V	Direct Illumination	15	POWER CORD (UK/US/EU) 24V Power Plug
6	LLA-90-100-1-B-24V	Direct Low Angle Illumination	16	24V POWER ADAPTER 24V Power Adaptor
7	DFR4-00-100-1-W-24V	Diffused Angular Illumination	17	EXT-24V-F-3M Extension Cable 3 Meter
8	DLR3-60-100-2-W-24V	Diffused Angular Illumination	18	EXT-24V-Y4-3M Extension Cable with 4 output cable
9	DLQ2-90-070-1-R-24V	Diffused Square Illumination	Remarks: Photo for reference only. The color of lighting can be choose based on application.	
10	HPD2-00-100-2-W-24V	Direct Uniform Ring Illumination		

Lighting Brackets LPS series

4 types of square lighting brackets which can be mounted on 10 types of TMS lighting

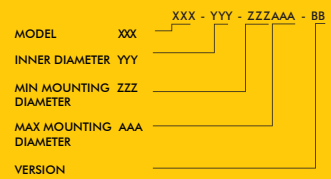

*Code applies to square brackets

SQUARE BRACKETS

LIGHTING

 <p>LPS-010-015035-01</p>	 <p>DLQ2-90-030</p>
 <p>LPS-026-035064-01</p>	   <p>LSQ-45-040 DLQ2-90-050 DLS2-60-050</p>
 <p>LPS-055-062099-01</p>	  <p>DLQ2-90-070 DLS2-60-070</p>
 <p>LPS-080-088136-01</p>	    <p>LBRQ-00-040-3 LBRQ-00-040-6 DLQ2-90-100-1 DLS2-60-100-1</p>

Lighting Brackets LP series

3 types of Dome brackets and 2 coaxial brackets which can be mounted on TMS lighting

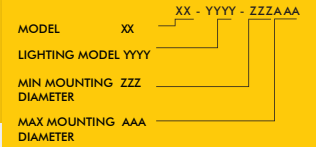

*Code applies to dome & coaxial brackets

DOME BRACKETS

LIGHTING

COAXIAL

LIGHTING



LP-IDS4-050



IDS4-00-050



CS-CAS25-01

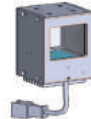

CAS2-00-025



LP-IDS4-070



IDS4-00-070

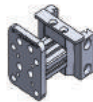

CS-CAS40-01

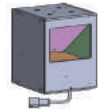

CAS2-00-040



LP-IDS4-100



IDS4-00-100

Lighting Bracket LPR Series

4 types of round lighting brackets which can be mounted on more than 50 types of TMS lighting

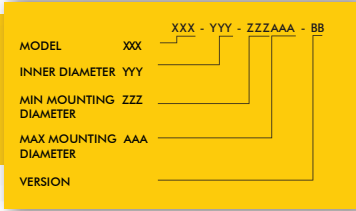

ROUND TYPE

LIGHTING



*Code applies to round brackets

Lens Retrofit

- Allow lens & lighting to be mounted simply into a vision module
- Space efficient
- Cost efficient

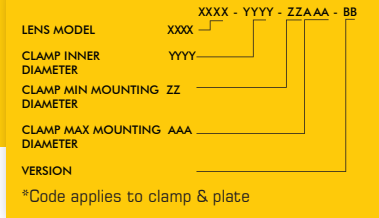

OPTO ENGINEERING

RETROFIT MK SERIES	LENS MODEL	CLAMP & PLATE	RETROFIT MC & MC3-03X SERIES	LENS MODEL	CLAMP & PLATE	LIGHTING
	MK1214	 MK32-M30.5-28070-01		MC 033X MC 050X MC 075X MC 100X MC 150X MC 200X MC 300X	 MC-15-28070-01	 DLR3 SERIES
	MK1614	 MK32-M30.5-49102-01		MC3-03X-SPACER	 MC-15-28102-01	 DFR4 SERIES
	MK2514 MK3520 MK5028	 MK32-M25.5-28070-01 MK32-M25.5-49102-01		 MC3-28-28102-01	 HPD2 SERIES	

Lens Retrofit **OPTART**

- Allow lens & lighting to be mounted simply into a vision module
- Space efficient
- Cost efficient

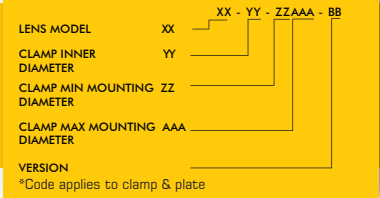

RETROFIT MP SERIES	LENS MODEL	CLAMP & PLATE	LIGHTING
	MP-1.5M-65	<p>MP29-28070-01 MP29-49102-01 MP32-28070-01 MP32-49102-01</p> <p>MP38-28070-01 MP38-49102-01 MP44-28070-01 MP44-49102-01</p> <p>MP50-28070-01 MP50-49102-01</p>	<p>DLR3 SERIES</p> <p>DFR4 SERIES</p> <p>HPD2 SERIES</p>
	MP-05M-65		
	MP-2M-65		
	MP-07M-65		
	MP-4M-65		
	MP-1M-65		
	MP-0.5M-110-2M		
	MP-1.5M-110-2M		
	MP-07M-110-5M		
	MP-05M-110-5M		
MP-1M-110-2M			
MP-2M-110-2M			
MP-1M-110-5M			
	HR-2M-65	<p>HR16-28070-01 HR16-28102-01</p> <p>HR25-28070-01 HR25-28102-01</p> <p>HR26-28070-01 HR26-28102-01</p> <p>HR18-28070-01 HR18-28102-01</p>	<p>DLR3 SERIES</p> <p>DFR4 SERIES</p> <p>HPD2 SERIES</p>
	HR-4M-65		
	HR-6M-65		
	HR-04M-78		
	HR-05S2-71		
	HR-05M-110		
	HR-08M-110		
	HR-08M-65		
	HR-2M-71		
	HR-2M-110		
HR-1M-65			
HR-4M-71			
HR-4M-110			
HR-07M-71			
HR-6M-71			
HR-6M-110			
HR-1M-71			
HR-1M-110			

COMPANY PROFILE

- FOUNDED ON 8TH OF NOVEMBER 2004
- DESIGN & MANUFACTURER OF LED LIGHTING FOR MACHINE VISION
- HEADQUARTERS IN PENANG, MALAYSIA.
- MORE THAN 12 YEARS OF EXPERIENCE IN THIS FIELD
- COMMITTED PERFORM RESEARCH AND DEVELOPMENT FOR NEW LED LIGHTINGS REQUIREMENTS

OUR PHILOSOPHY

- DELIVER VALUE-ADDED SOLUTION
- EDUCATION
- DELIVER HIGH PERFORMANCE PRODUCT

OUR SERVICES

- ONE STOP SOLUTION FOR MACHINE VISION SYSTEM (E.G. ILLUMINATORS, LENS, FILTERS, ETC.).
- CUSTOMIZE LED LIGHTINGS AND CONTROLS, TARGETED FOR SPECIAL LIGHTINGS APPLICATIONS.
- TRAINING & WORLD CLASS LABORATORY (ILLUMINATIONS, OPTICS & ETC.).



CONTACT US

TMS LITE SDN. BHD. (671971V)

No, 2A-2, Tingkat Kenari 5, Desa Ria,
Sungai Ara, 11900 Penang, Malaysia.

Tel : +604 646 8428

Fax: +604 646 3428

Website : www.tms-lite.com

Email :

For Quotation
sales@tms-lite.com

For Demo Unit
demo@tms-lite.com

For Technical
support@tms-lite.com

For Application
application@tms-lite.com